

# MPF series

Maximum working pressure up to 800 kPa (8 bar) - Flow rate up to 750 l/min



## Description

## Technical data

### Return filter

**Maximum working pressure up to 800 kPa (8 bar)**

**Flow rate up to 750 l/min**

MPF is a range of return filters for protection of the reservoir against the system contamination.

They are directly fixed to the reservoir, in immersed or semi-immersed position.

The filter output must be always immersed into the fluid to avoid aeration or foam generation into the reservoir.

### Available features:

- Female threaded connections up to 2" and flanged connections up to 2", for a maximum flow rate of 750 l/min
- Multiple connections, to connect several return lines or drains
- Fine filtration rating, to get a good cleanliness level into the reservoir
- Bypass valve integrated into the filter element, to relieve excessive pressure drop across the filter media
- 2, 3 or 4 fixing holes for installation, to meet any reservoir surface flatness and roughness
- O-ring or Flat seal, to meet any reservoir surface flatness and roughness
- Oil dipstick, to easily check the level of the fluid into the reservoir (sold as separate item)
- Extension tube, to be used in deep reservoirs (sold as separate item)
- Diffuser, to reduce the risk of aeration, foaming and noise (sold as separate item)
- Filler plug, to fill cleaned fluid into the tank without an additional connection
- Visual, electrical and electronic clogging indicators

### Common applications:

- Light industrial equipment
- Mobile application

### Filter housing materials

- Head: Aluminium
- Cover  
Nylon: MPF 020-030-100-104-110  
Aluminium: MPF 181-182-184-191-192-194-400-410-450-451-750
- Bowl: Nylon

### Bypass valve

- Opening pressure 175 kPa (1.75 bar) ±10%
- Opening pressure 300 kPa (3 bar) ±10%

### Δp element type

- Microfibre filter elements - series H: 10 bar
- Fluid flow through the filter element from OUT to IN

### Seals

- Standard NBR series A
- Optional FPM series V

### Temperature

From -25 °C to +110 °C

### Note

MPF filters are provided for vertical mounting



## Weights [kg] and volumes [dm<sup>3</sup>]

Filter series	Weights [kg]				Volumes [dm <sup>3</sup> ]					
	Length	1	2	3	4	Length	1	2	3	4
<b>MPF 020</b>		0.30	-	-	-		0.26	-	-	-
<b>MPF 030</b>		0.40	-	-	-		0.29	-	-	-
<b>MPF 100</b>		0.61	0.64	0.67	0.74		0.64	0.85	1.20	1.65
<b>MPF 104</b>		0.82	0.96	1.02	1.25		0.64	0.85	1.20	1.65
<b>MPF 110</b>		0.64	0.68	0.71	0.78		-	-	-	-
<b>MPF 181</b>		2.20	3.00	-	-		2.50	4.00	-	-
<b>MPF 182</b>		2.30	3.10	-	-		2.50	4.00	-	-
<b>MPF 184</b>		2.55	3.45	-	-		2.65	4.45	-	-
<b>MPF 191</b>		-	3.00	-	-		-	4.25	-	-
<b>MPF 192</b>		-	3.10	-	-		-	4.25	-	-
<b>MPF 194</b>		-	3.45	-	-		-	4.45	-	-
<b>MPF 400</b>		3.35	3.65	3.90	-		3.70	4.60	5.40	-
<b>MPF 410</b>		3.55	3.85	4.10	-		3.70	4.60	5.40	-
<b>MPF 450-451</b>		3.95	4.25	4.50	-		3.70	4.60	5.40	-
<b>MPF 750</b>		6.30	-	-	-		8.45	-	-	-

### Filter housings $\Delta p$ pressure drop

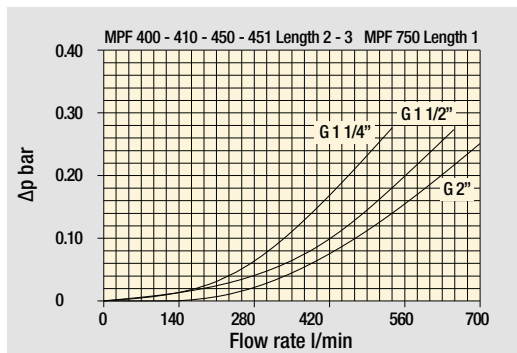
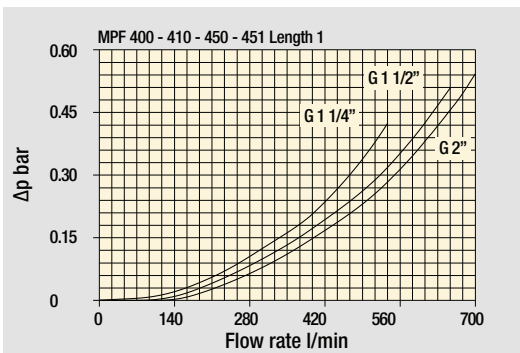
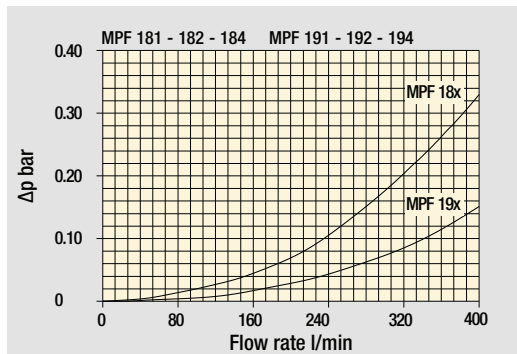
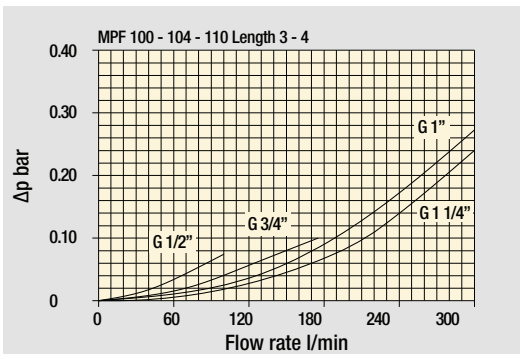
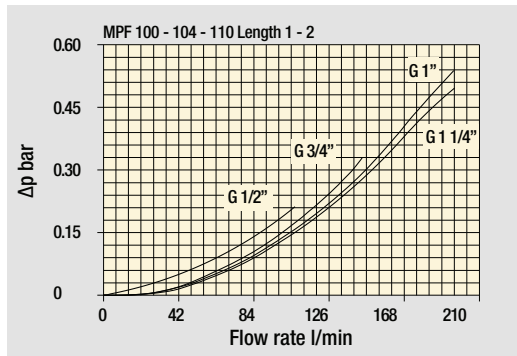
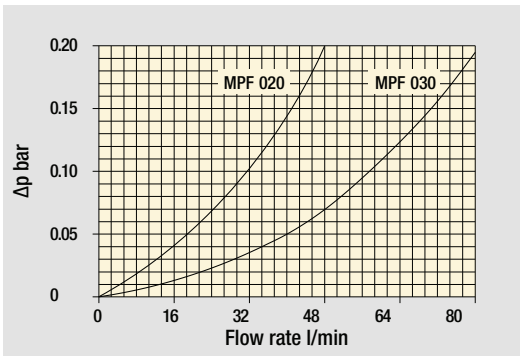

### Bypass valve pressure drop

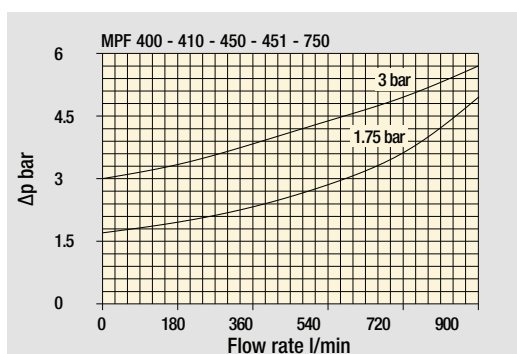
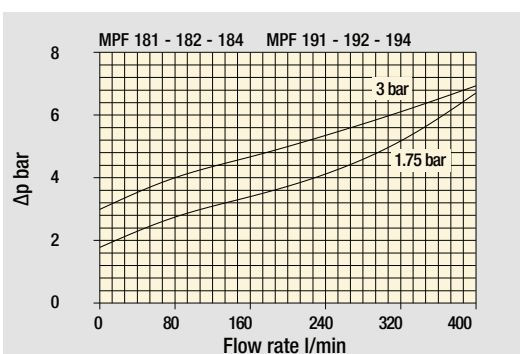
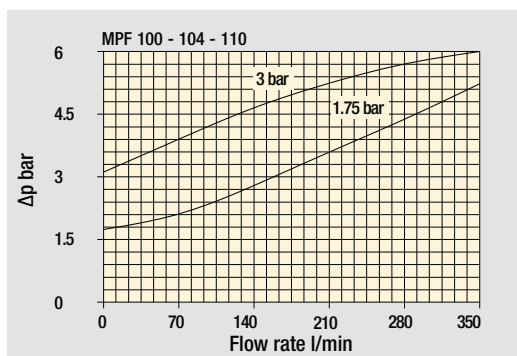
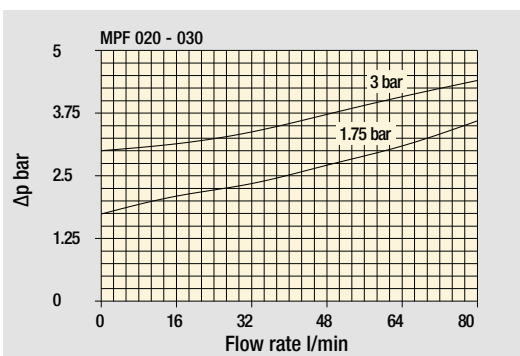

The curves are plotted using mineral oil with density of 0.86 kg/dm<sup>3</sup> in compliance with ISO 3968.  
 $\Delta p$  varies proportionally with density.

# MPF GENERAL INFORMATION

Flow rates [l/min]

Filter series	Length	Filter element design - H series					Filter element design - N series		
		A03	A06	A10	A16	A25	M25 M60 M90	P10	P25
<b>MPF 020</b>	<b>1</b>	7	10	23	28	42	59	51	54
<b>MPF 030</b>	<b>1</b>	7	10	24	29	47	84	60	66
<b>MPF 100-104-110</b>	<b>1</b>	18	20	53	56	65	153	87	96
	<b>2</b>	28	38	65	75	95	158	111	123
	<b>3</b>	48	55	125	135	169	289	224	251
	<b>4</b>	79	89	180	185	198	306	264	289
<b>MPF 181-182-184</b>	<b>1</b>	127	148	235	243	278	441	285	299
	<b>2</b>	231	262	358	382	388	472	404	412
<b>MPF 191-192-194</b>	<b>2</b>	261	305	489	528	546	696	583	598
<b>MPF 400</b>	<b>1</b>	150	171	294	304	350	585	370	390
	<b>2</b>	237	252	454	462	589	868	619	645
	<b>3</b>	248	288	553	609	621	885	680	703
<b>MPF 410</b>	<b>1</b>	146	167	277	285	325	512	341	357
	<b>2</b>	226	239	396	402	485	644	503	519
	<b>3</b>	236	269	462	497	505	653	539	553
<b>MPF 450-451</b>	<b>1</b>	150	171	294	304	350	585	370	390
	<b>2</b>	237	252	454	462	589	868	619	645
	<b>3</b>	248	288	553	609	621	885	680	703
<b>MPF 750</b>	<b>1</b>	392	465	623	700	769	929	804	819

## Maximum flow rate for a complete return filter with a pressure drop $\Delta p = 0.5$ bar.

The reference fluid has a kinematic viscosity of 30 mm<sup>2</sup>/s (cSt) and a density of 0.86 kg/dm<sup>3</sup>.

For different pressure drop or fluid viscosity we recommend to use our selection software available on [www.mpfiltri.com](http://www.mpfiltri.com).

Please, contact our Sales Department for further additional information.

## Hydraulic symbols

Filter series	Style 1 connection	Style 2 connections
<b>MPF 020</b>	•	
<b>MPF 030</b>	•	
<b>MPF 100</b>	•	
<b>MPF 104</b>	•	
<b>MPF 110</b>		•
<b>MPF 181</b>	•	
<b>MPF 182</b>		•
<b>MPF 184</b>	•	•
<b>MPF 191</b>	•	
<b>MPF 192</b>	•	
<b>MPF 194</b>	•	•
<b>MPF 400</b>	•	
<b>MPF 410</b>		•
<b>MPF 450</b>	•	
<b>MPF 451</b>		•
<b>MPF 750</b>	•	

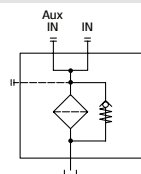
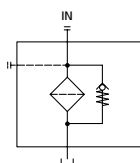

# MPF MPF181 - MPF191

## Designation & Ordering code

### COMPLETE FILTER

<b>Series and size</b>			Configuration example 1: <b>MPF181</b>   <b>1</b>   <b>A</b>   <b>G1</b>   <b>A25</b>   <b>H</b>   <b>E</b>   <b>P01</b>								
<b>MPF181</b>   <b>MPF191</b> Filter element with standard spigot			Configuration example 2: <b>MPF191</b>   <b>2</b>   <b>V</b>   <b>G2</b>   <b>P10</b>   <b>N</b>   <b>B</b>   <b>P01</b>								
<b>Length</b>		<b>Size 181</b>	<b>Size 191</b>								
<b>1</b>		•									
<b>2</b>		•	•								
<b>Seals and treatments</b>											
<b>A</b> NBR	<b>B</b> NBR flat seal on head										
<b>V</b> FPM	<b>D</b> FPM flat seal on head										
<b>W</b> NBR head anodized	<b>L</b> NBR head anodized, flat seal on head										
<b>Z</b> FPM head anodized	<b>M</b> FPM head anodized, flat seal on head										
<b>Connections</b>											
<b>G1</b> G 1 1/4"	<b>G5</b> 1 1/2" NPT										
<b>G2</b> G 1 1/2"	<b>G7</b> SAE 20 - 1 5/8" - 12 UN										
<b>G4</b> 1 1/4" NPT	<b>G8</b> SAE 24 - 1 7/8" - 12 UN										
<b>Filtration rating (filter media)</b>											
<b>A03</b> Inorganic microfiber 3 µm	<b>M25</b> Wire mesh 25 µm										
<b>A06</b> Inorganic microfiber 6 µm	<b>M60</b> Wire mesh 60 µm										
<b>A10</b> Inorganic microfiber 10 µm	<b>M90</b> Wire mesh 90 µm										
<b>A16</b> Inorganic microfiber 16 µm	<b>P10</b> Resin impregnated paper 10 µm										
<b>A25</b> Inorganic microfiber 25 µm	<b>P25</b> Resin impregnated paper 25 µm										
			Filter media								
<b>Element Δp</b>	<b>Axx</b>	<b>Mxx</b>	<b>Pxx</b>								
<b>N</b> 10 bar		•	•								
<b>H</b> 10 bar		•									
<b>W</b> 10 bar, compatible with fluids HFA, HFB and HFC	•	•									
			Bypass valve		Execution						
			<b>E</b> 3 bar		<b>P01</b> MP Filtri standard						
			<b>B</b> 1.75 bar		<b>Pxx</b> Customized						

### FILTER ELEMENT

<b>Element series and size</b>			Configuration example 1: <b>MF180</b>   <b>1</b>   <b>A25</b>   <b>H</b>   <b>B</b>   <b>E</b>   <b>P01</b>								
<b>MF180</b>   <b>MF190</b> Filter element with standard spigot			Configuration example 2: <b>MF190</b>   <b>2</b>   <b>P10</b>   <b>N</b>   <b>V</b>   <b></b>   <b>P01</b>								
<b>Element length</b>		<b>Size 180</b>	<b>Size 190</b>								
<b>1</b>		•									
<b>2</b>		•	•								
<b>Filtration rating (filter media)</b>											
<b>A03</b> Inorganic microfiber 3 µm	<b>M25</b> Wire mesh 25 µm										
<b>A06</b> Inorganic microfiber 6 µm	<b>M60</b> Wire mesh 60 µm										
<b>A10</b> Inorganic microfiber 10 µm	<b>M90</b> Wire mesh 90 µm										
<b>A16</b> Inorganic microfiber 16 µm	<b>P10</b> Resin impregnated paper 10 µm										
<b>A25</b> Inorganic microfiber 25 µm	<b>P25</b> Resin impregnated paper 25 µm										
			Filter media								
<b>Element Δp</b>	<b>Axx</b>	<b>Mxx</b>	<b>Pxx</b>								
<b>N</b> 10 bar		•	•								
<b>H</b> 10 bar		•									
<b>W</b> 10 bar, compatible with fluids HFA, HFB and HFC	•	•									
			Seals		Bypass valve		Execution				
			<b>B</b> NBR		<b>E</b> 3 bar		<b>P01</b> MP Filtri standard				
			<b>V</b> FPM		<b></b> 1.75 bar		<b>Pxx</b> Customized				

### ACCESSORIES

<b>Indicators</b>		page			page
<b>BVA</b> Axial pressure gauge	240		<b>BEA</b> Electrical pressure indicator	239	
<b>BVR</b> Radial pressure gauge	240		<b>BEM</b> Electrical pressure indicator	239	
<b>BVP</b> Visual pressure indicator with automatic reset	241		<b>BLA</b> Electrical / visual pressure indicator	239-240	
<b>BVQ</b> Visual pressure indicator with manual reset	241				
<b>Additional features</b>		page			
<b>TE</b> Extension tube	248				
<b>Sxx</b> Extension tube	248				
<b>T5</b> Filler plug M30x1.5	249				

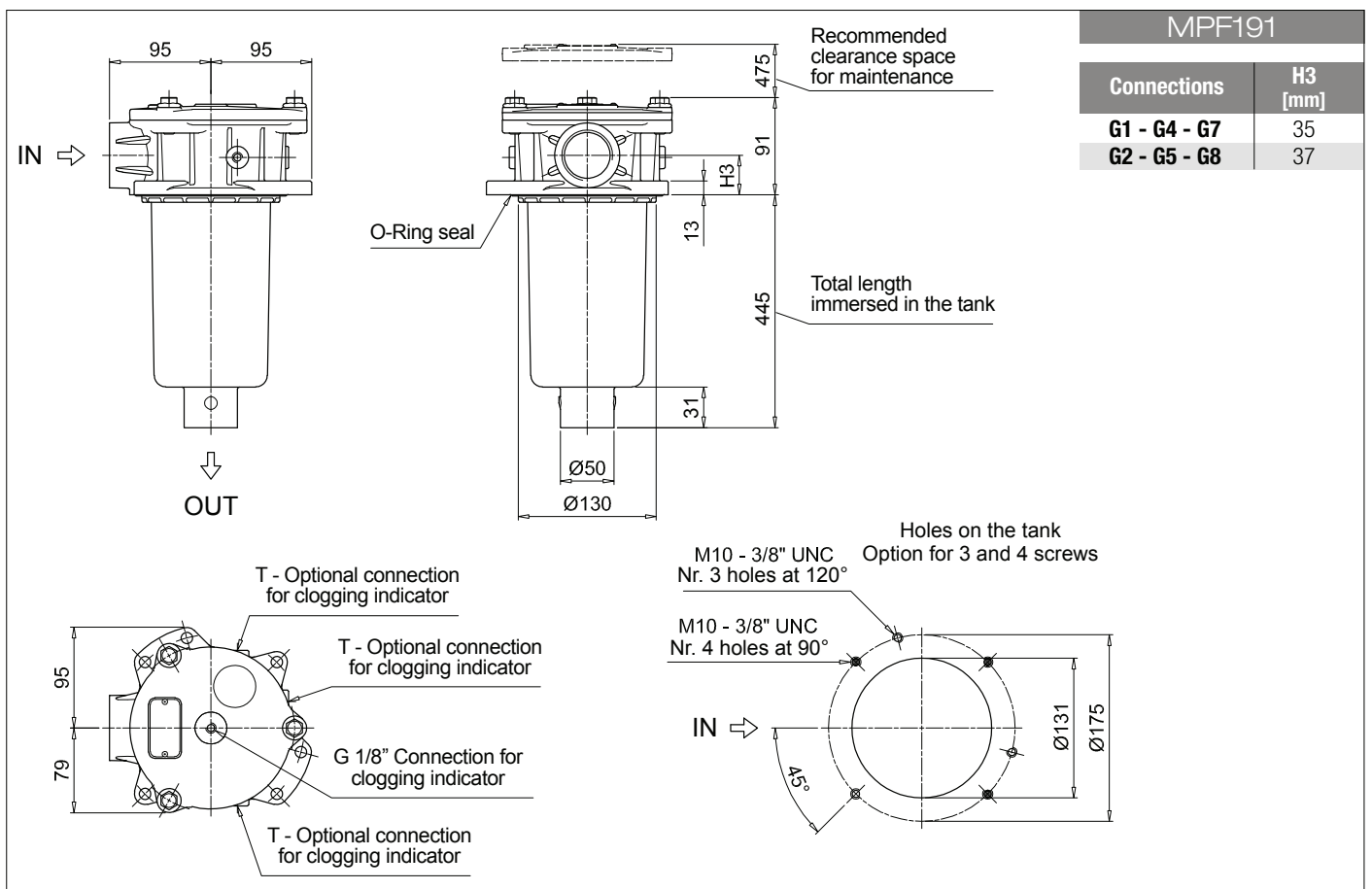
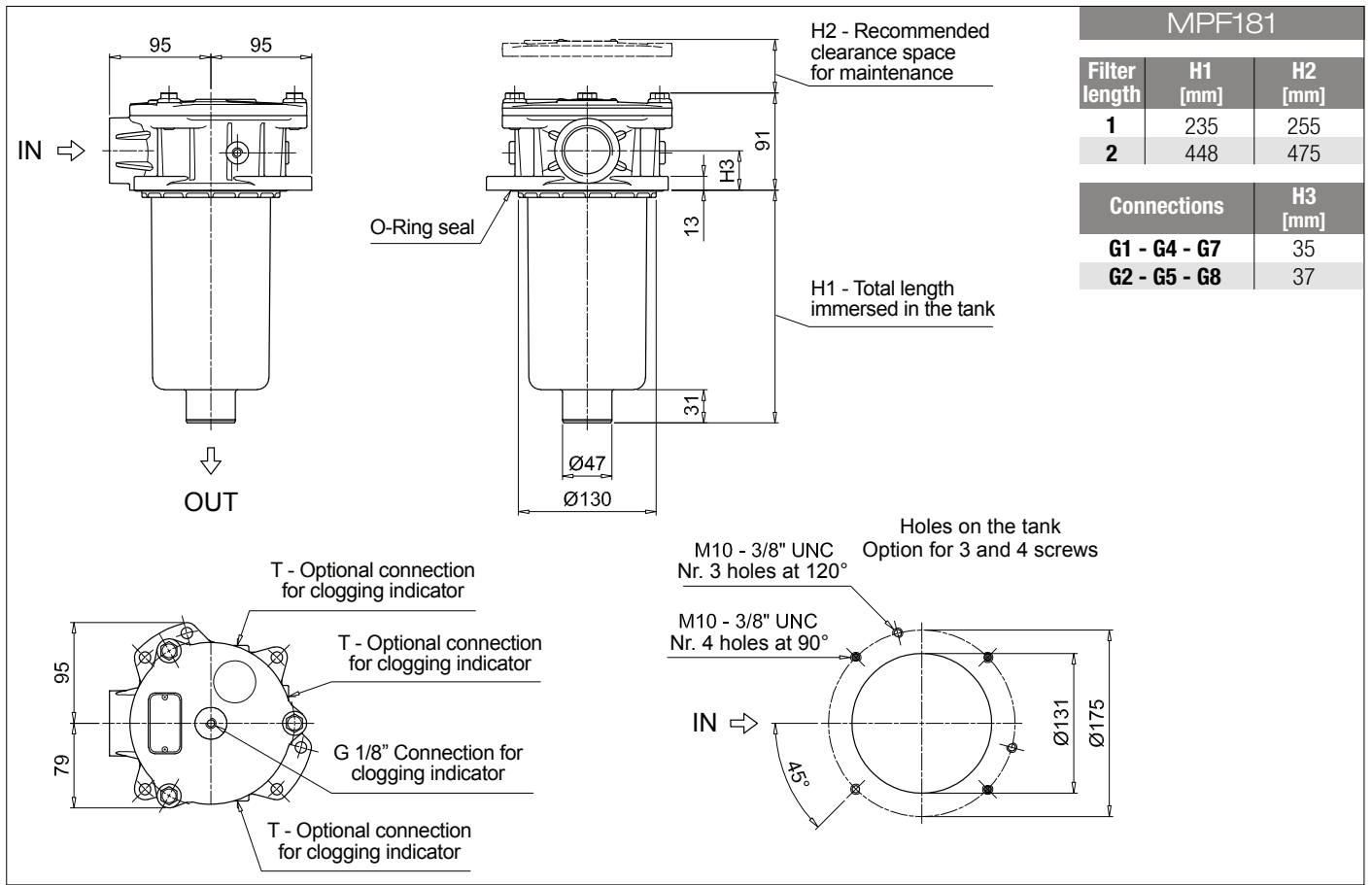

**MPF 100**

**MPF 181**

**O-RING SEAL**

Item:	Q.ty: 1 pc.	Q.ty: 1 pc.	
	<b>2</b>	<b>3</b> (3a ÷ 3d)	
Filter series	Filter element	Seal Kit code number NBR	FPM
<b>MPF 030</b>	See order table	02050055	02050056
<b>MPF 100-110</b>		02050057	02050058
<b>MPF 181-182</b>		02050059	02050060
<b>MPF 184</b>		02050455	02050456
<b>MPF 191-192</b>		02050457	02050458
<b>MPF 194</b>		02050459	02050460
<b>MPF 400-410</b>		02050061	02050062
<b>MPF 450-451</b>		02050461	02050462
<b>MPF 750</b>		02050106	02050107

**MPF 104**

**MPF 181**

**FLAT SEAL**

Item:	Q.ty: 1 pc.	Q.ty: 1 pc.	
	<b>2</b>	<b>3</b> (3a ÷ 3d)	
Filter series	Filter element	Seal Kit code number NBR	FPM
<b>MPF 020</b>	See order table	02050438	02050439
<b>MPF 104</b>		02050350	02050408
<b>MPF 181-182</b>		02050659	02050660
<b>MPF 191-192</b>		02050661	02050662